

VEGA

design
SERGIO BELLIN



SitLand®

THE MODERN DESIGN

A technical seat re-invented to ensure comfort and all the benefits of ergonomics. Vega quality and style live in the different geometries that dress it up, and trendy details.



THE DESIGN METAMORPHOSIS

Vega is the collection that stands out for its design. Handicraft stitching design the upholsteries, giving shape to refined geometries: large square patterns for Vega S, matelassé for Vega Q, striped for Vega L.

STANDARD CLASS

From the executive to the manger version, up to the meeting version with casters or fixed gliders: Vega furnishes different spaces with style and elegance.

THE MECHANICS OF OF COMFORT

Vega features a dynamic knee tilt mechanism of new generation with tilt limiter, lockable in 5 positions and anti-panic system. The tilt tension can be adjusted by a practical side handle, according to the user's weight.

COMFORTABLE AND STURDY

In addition to its sought-for aesthetics, Vega is also sturdy and comfortable thanks to the back and seat pad in flexible polyurethane, crushproof. The inner structure is in reinforced moulded steel to last in time.

ELEGANT ALSO IN THE DETAILS

Different types of upholstery, bases and casters offer the possibility to choose the most suitable version for your needs.

The outer structure in steel tube is available chromed or painted in glossy black with elegant final caps in chromed ABS.

The armrests integrated in the seat match the structure and can be upholstered with a top in the same material as the armchair.

MODELS AND DIMENSIONS

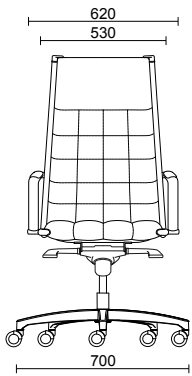

Executive

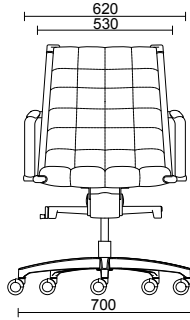
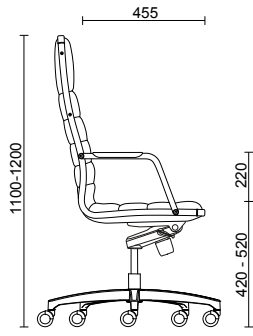

Manager

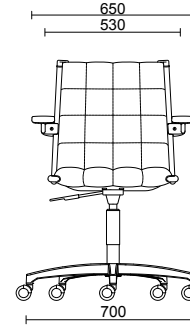
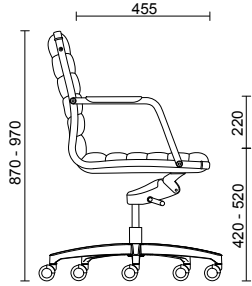

Meeting

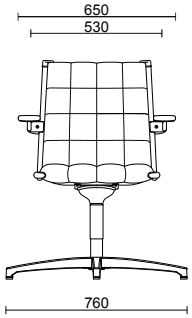
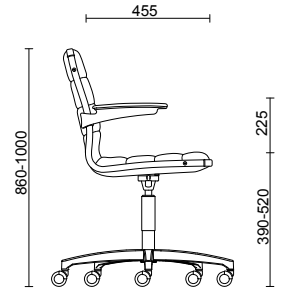

Meeting

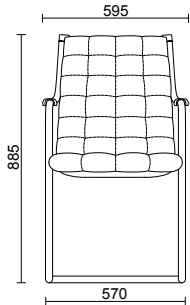
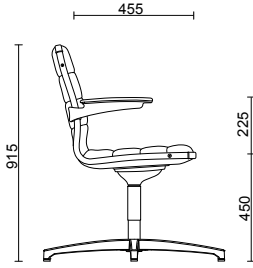

Visitor chair

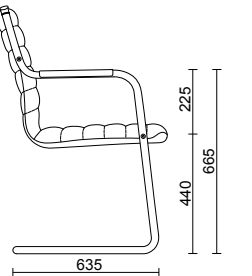

MECHANISM

	EXECUTIVE	MANAGER	MEETING
New generation dynamic knee tilt mechanism, lockable in 5 positions with anti-shock system. Tilt tension adjustment by means of a side handle.	<input type="checkbox"/>	<input type="checkbox"/>	
Dynamic knee tilt mechanism, for the chair angle regulation, lockable in 4 positions with anti-shock system. Tilt tension adjustment.	<input type="checkbox"/>	<input type="checkbox"/>	
Soft tilt, for meeting rooms, with progressive tilt toward the back, and a light tilt toward the front.			<input type="checkbox"/>
Gas lift adjustment.	<input type="checkbox"/>	<input type="checkbox"/>	<input type="checkbox"/>
Seat with fixed height with memory return mechanism.			<input type="checkbox"/>

BASES



5 star die-cast aluminium base, polished, ø 700 mm.



5 star die-cast aluminium base, glossy black painted with transparent anti-scratch treatment, ø 700 mm.



4 star die-cast aluminium base, polished, ø 760 mm.



4 star die-cast aluminium base,
GLOSSY BLACK painted with transparent
anti-scratch treatment, ø 760 mm.

CASTERS



Self-braking casters, ø 65 mm.



Free casters, ø 65 mm for soft
floors.



Self-braking rubber casters, ø
65 mm for hard floors.



Hollow free and rubber
casters, ø 65 mm for hard
floors, black structure.



Hollow free and rubber
casters, ø 65 mm, for hard
floors, chromed structure.

COLOURS, MATERIALS, FINISHING *

STRUCTURE FINISHING



Glossy
black
painted
steel



Chromed steel

BACK AND SEAT PATTERN

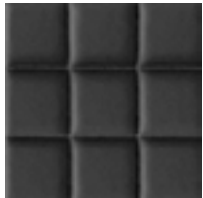

Vega S

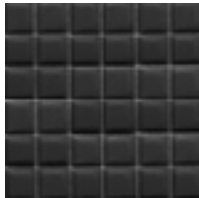

Vega Q

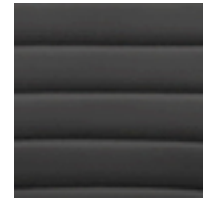

Vega L

UPHOLSTERY



Fabric
FE
21 colours



Ecological
leather CI-CX
26 colours



Ecological
leather IK
13 colours



Leather
TS
18 colours



Leather
S
13 colours



Ecological
leather N
13 colours



Leather
S
13 colours

+



Ecological
leather N
13 colours

COVER ARMS UPHOLSTERY



Fabric
FE
21 colours



Ecological
leather CI-CX
26 colours



Ecological
leather IK
13 colours



Leather
TS
18 colours



Leather
S
13 colours



Ecological
leather N
13 colours



Leather
S
13 colours

+



Ecological
leather N
13 colours

* Please refer to the Price list in force and to the General sale conditions for the colours and the combinations available for every single product.
Colours shown are used for reference only and may look different in reality. Please contact SitLand to receive more information.

PCON.PLANNER



It is possible to configurate our model Vega by using pCon.planner program for the design of 2D an 3D environment.

pCon.planner allows to design working solutions in a fast and intuitive way, creating "realistic" images with advanced features, with a considerable saving of time and resources.

It is easy to start using pCon.planner: after downloading the software in the proper page, it is possible to download pCon.catalog, the practical online catalogue of products ready to be set up according to anyone's need, and then include the products in the projects.

For more information on the use of pCon.planner and the access to the products of the SitLand's catalogues, please contact com@sitland.com

WARRANTY



Vega has 5 years warranty.
For any further detail, please contact SitLand's customer service at service@sitland.com

MORE INFORMATIONS

Please look through our catalogue to see all the different versions available of Vega

http://www.sitland.com/sitland_catalogues/sitland_general_catalogue/sitland_general_catalogue.html#p=84

or see our Vega page into our web site www.sitland.com

Vega comply with the italian norm D.Lgs. 81/2008.

Vega comply with the norm UNI EN 1335-3

The work conditions and the protection of the people at work, as far as safety and health are concerned, provide that "the office chairs" are produced according to the ergonomic principles and the functionality requirements contained in the following norms:

- UNI EN 1335-1, dimensions and definitions of the dimensions;
- UNI EN 1335-2, safety requirements
- UNI EN 1335-3, test procedures for the safety

The chairs are classified in three different classes according to their specific performance and dimensional characteristics:

- Class A considers the more restrictive dimensional requirements and mostly respect the anthropometric dimensions from 5 to 95% of the population.
- Class B considers the middle requirements among the classes , respecting the minimum requirements requested by D.Lgs. 81/2008.
- Class C considers the minimum requirements.

The tests performed are:



on the model Vega S executive with dynamic knee tilt mechanism, arms and 5 star die-cast aluminium base, ø 700 mm.

STATIC LOAD ON THE FRONT OF THE SEAT

Carico: 1.600 N
Number of cycles: 10

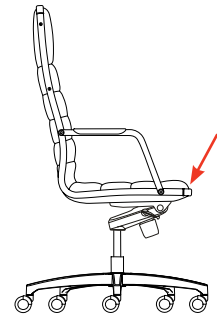

SEAT AND BACK STATIC LOAD TEST

Loading point A: 1.600 N
Loading point B: 560 N
Number of cycles: 10

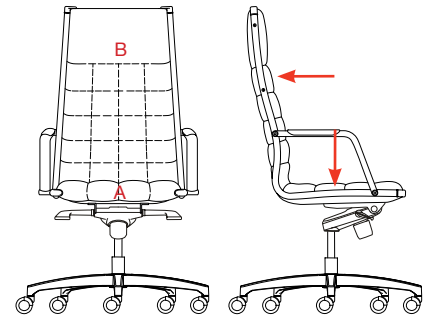

DURABILITY TESTS ON THE SEAT AND BACK

Loading point A: 1.500 N
Number of cycles: 120.000
Loading point C - B: 1.200 N - 320 N -
Number of cycles: 80.000
Loading point J - E: 1.200 N - 320 N -
Number of cycles: 20.000
Loading point F - H: 1.200 N - 320 N -
Number of cycles: 20.000
Loading point D - G: 1.100 N - 1.100 N -
Number of cycles: 20.000

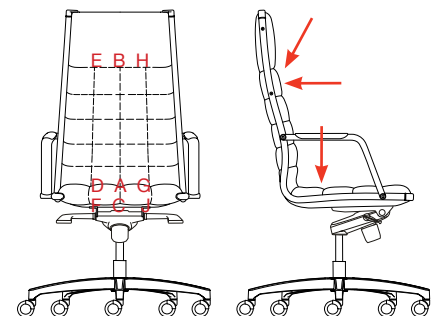

DURABILITY TESTS OF THE ARMREST

Application point compared to the most forward point of the armrest: 100 mm
 Load: 400 N
 Number of cycles: 60.000

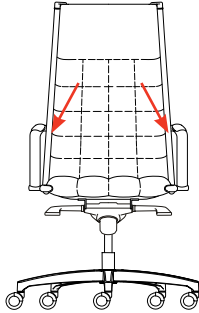

STABILITY TESTS – FRONT TILTING

Load: 27 kg
 Applied in the furthest point of the seat from the rotation axis

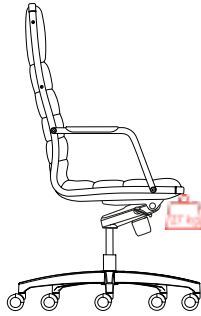

VERTICAL STATIC LOAD AT THE CENTRE OF THE ARM

Loading point: center
 Load: 900 N
 Number of cycles: 5

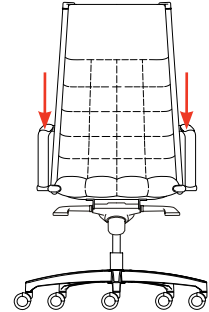

STABILITY TESTS - TILT TOWARD THE FRONT

Vertical force: 600 N
 Application point: 60 mm
 Carico: 20 N
 Loading time: 5 sec

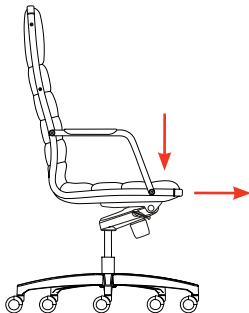

STABILITY TESTS FOR SWIVELING CHAIRS – TILT TOWARD THE BACK FOR CHAIRS WITH FIXED BACK

Vertical force in A: 600 N
 Load in B: 192 N
 Loading point: A

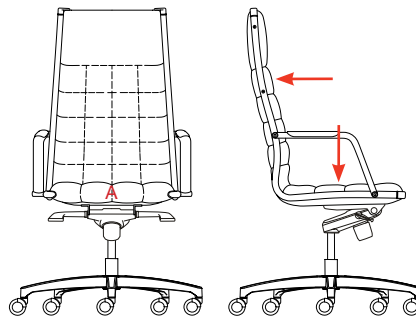

RESISTANCE TO ROLLING OF THE SEAT WITH NO LOAD

Test speed: 50 mm/s
 Measured resistance: 19,4 N
 Minimum allowed resistance: 12 N

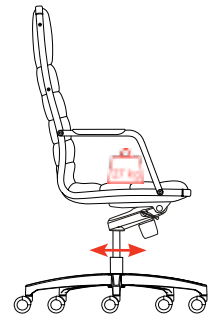

STABILITY TESTS – LATERAL TILTING

Seat vertical force: 250 N
 Armrest vertical force: 350 N
 Armrest lateral force: 20 N

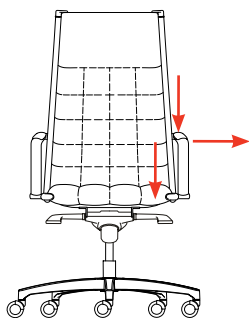

STABILITY TESTS - BACK TILTING FOR SEATS WITH TILTING BACK

Number of discs: 13



SitLand®

SitLand S.p.A.
Via Cà Silvestre, 52
36024 Nanto - Vicenza - Italy
info@sitland.com - www.sitland.com
Tel. +39 0444 637100

SitLand S.p.A. is certified
UNI EN ISO 9001: 2008
UNI EN ISO 14001: 2004



Follow us

